

Technical specification 3085.181

The Flygt 3085.181 submersible pump with a capacity of up to 35 l/s covers a number of applications.

The electric motor and the pump comprise a compact and robust unit which requires little space and is easy to handle.

The basic model is designed to pump liquid containing solid particles, such as sewage or waste water. It can also be used to pump clean water or raw water.

INSTALLATION ALTERNATIVES

The pump is submersible, compact and is simple to install. The basic models are available in one or more versions, depending on the method of installation.

Standard model

The pump casing and the single-vane impellers can pass solids with diameters up to 100 mm. Swirl-type impellers are also available.

CP/DP

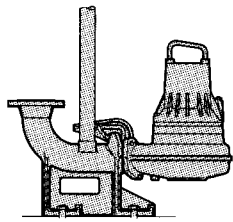

This system with guide bar and discharge connection permits automatic connection of the pump to the discharge line. The pump can be removed for inspection without anyone having to enter the sump.

The pump will work completely or partially submerged in the liquid being pumped.

CS/DS CF/DF

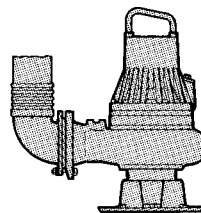

A portable pump intended for operating completely or partially submerged in the pumped liquid. It is equipped with a base stand or legs and a discharge hose connection.

DIMENSIONS

All dimensions in mm (in)

CS-LT

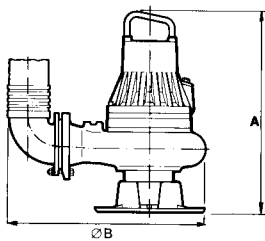

A **ØB**
660 (26) 638 (25.1)

CS/DS-MT

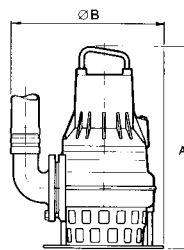

A **ØB**
603 (23.7) 480 (18.9)

CS-HT

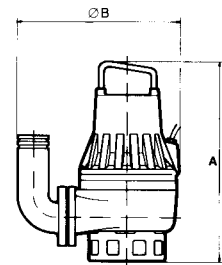

A **ØB**
512 (20.2) 450 (17.7)

DS-HT

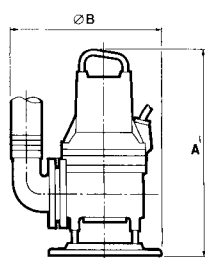

A **ØB**
548 (21.6) 460 (18.1)

CF/DF-MT

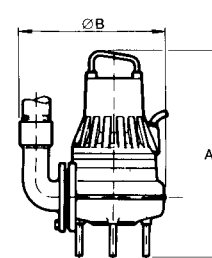

A **ØB**
586 (23.1) 472 (18.6)

PERFORMANCE CURVES

Each pump is tested in accordance with ISO 2548 class C standard.

└ = Optimum operating point

**CP/CS
LT 3-phase**
Input kW

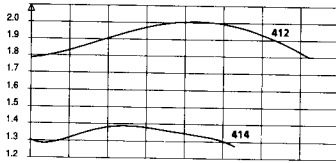

Head m

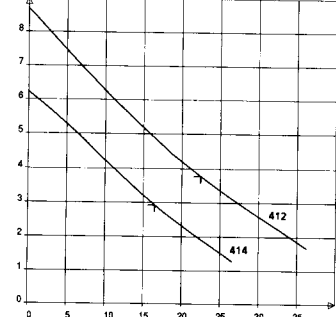

Capacity l/s

**CP/CS
LT 3-phase**
Input kW

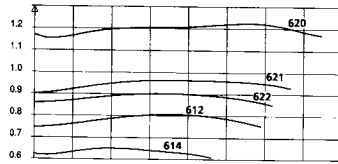

Head m

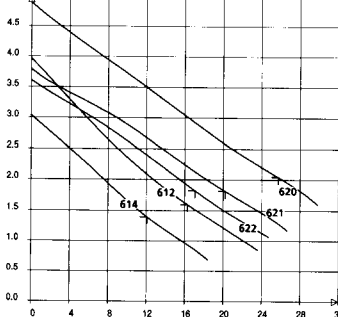

Capacity l/s

**CP/CS/CF
MT 1-phase**
Input kW

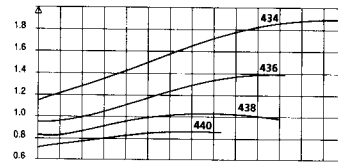

Head m

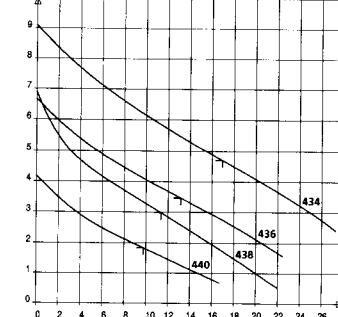

Capacity l/s

**CP/CS/CF
MT 3-phase**
Input kW

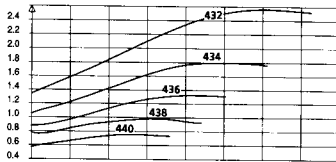

Head m

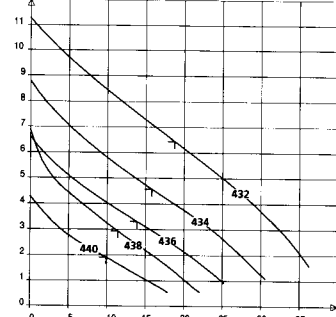

Capacity l/s

**CP/CS/CF
MT 3-phase**
Input kW

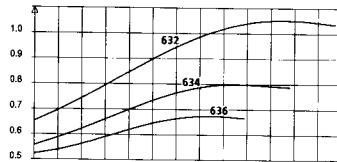

Head m

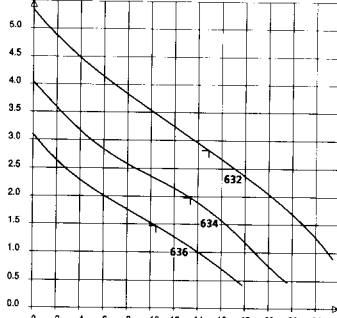

Capacity l/s

**CP/CS
HT 3-phase**
Input kW

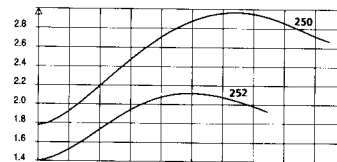

Head m

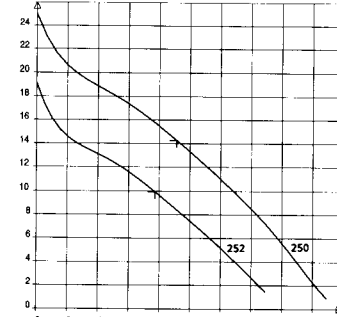

Capacity l/s

**DP/DS/DF
HT, MT 3-phase**
Input kW

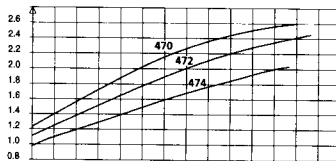

Head m

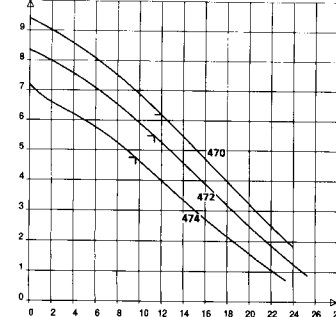

Capacity l/s

**DP/DS/DF
MT 1-phase**
Input kW

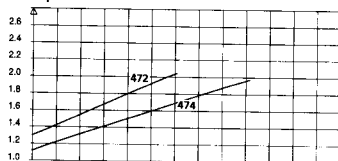

Head m

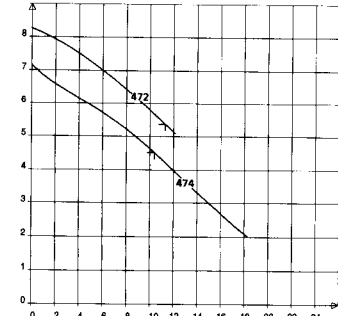

Capacity l/s

**DP/DS/DF
HT 3-phase**
Input kW

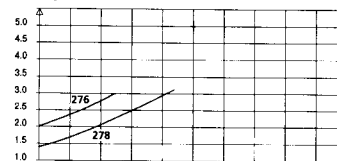

Head m

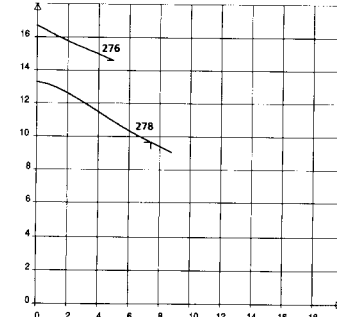

Capacity l/s

DESIGN

1. Junction box

The junction box is completely sealed off from the surrounding liquid.

2. Cooling

The stator is cooled by the liquid surrounding the stator casing.

3. Motor

Flygt's motors are tested according to IEC 34-1.

Motor insulation to Class F means a maximum working temperature of 155°C (310°F) and permits a temperature rise of 100°C (212°F).

The temperature rise in Flygt motors does not normally exceed 80°C (175°F). The insulation material is chosen with the greatest care, and most materials are classified as Class H (180°C, 355°F) materials or very close to Class H. This means an expected service life far beyond what is required for Class F.

4. Bearings

The lower bearing consists of a double row angular contact ball bearing and the upper is a single-row ball bearing.

5. Shaft seals

The pump has two mechanical seals. The seals work independently of each other and seal off the motor from the pump section.

6. Oil casing

The oil lubricates and cools the seals and acts as a buffer between the pumped liquid and the electric motor.

Pressure build-up within the oil casing is reduced by means of a built-in volume of air.

7. Wear rings

The pump casing is equipped with an easily replaceable wear ring.

The cutter model has no wear rings.

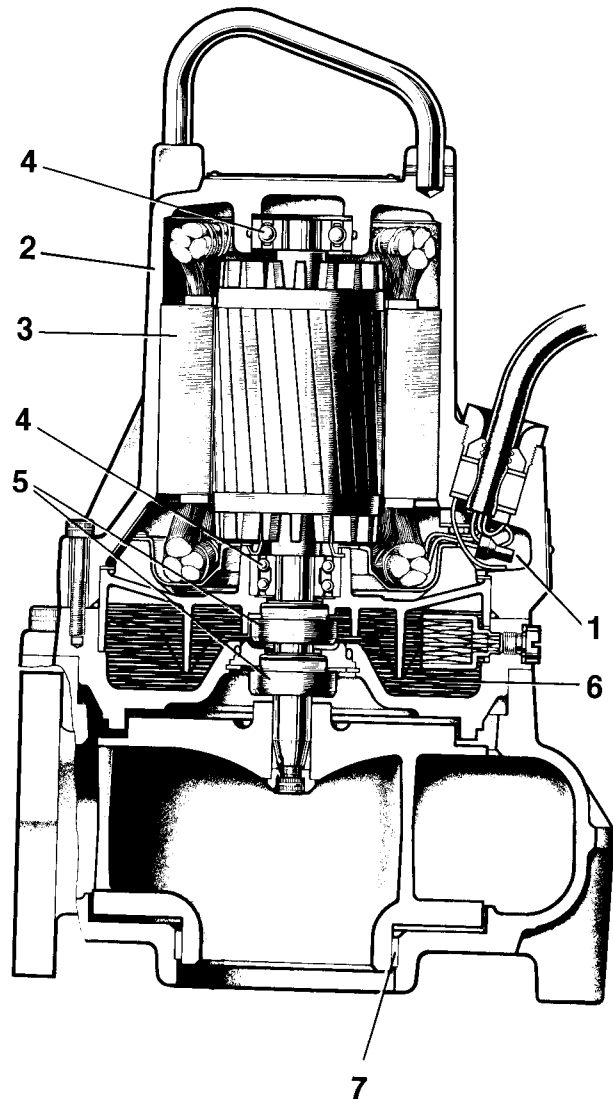

Monitoring equipment

The stator incorporates two thermal switches connected in series.

The thermal switches open at 125°C (255°F).

The pump is available with leakage sensors for sensing the presence of any water in the oil and/or stator housing.

Special executions

This pump is available in special execution for:

- Liquid manure, containing long-fibred material (F3085.181).
- lift model, for land drainage. (LL 3085.181).
- liquid temperatures up to 90°C (195°F).
- explosive environments approved according to EN or NEC by FM certified (3085.181 in its standard version is CSA approved).

The 3085 is also available for 60 Hz.

TECHNICAL DATA

Pump type	Curve No.	Squirrel-cage, 3 phase A.C. motor, insulation class F, 50 Hz						
		Rated power			Rated current			
		kW	hp	r/min	220V	380V	415V	500V
LT, MT	612,614,620, 621,622,632* 634*,636*	0.9	1.2	935	5.4A	3.1A	2.8A	2.4A
LT, MT	414,434*,436*,438, 440	1.3	1.8	1400	5.6A	3.2A	2.9A	2.4A
LT, MT	412,432*,470,472,474	2.0	2.7	1400	8.1A	4.7A	4.3A	3.6A
HT	250,252,276,278	2.4	3.2	2850	8.5A	4.9A	4.5A	3.7A

* Neva clog®

Single-phase MT

Squirrel-cage motor, insulation class F, 50 Hz

Curve No.	Rated power		r/min	Rated current	
	kW	hp		220V	240V
436*, 438, 440	0.95	1.25	1435	6.3A	6.1A
434	1.5	2.0	1440	9.3A	8.5A

Power cable: 4 × 2.5 mm²

Your Flygt representative will provide details of cables required to comply with local regulations.

Weights

Pump Units			
Version	Motor Size	Weight	
LT 4-pole	2.0 kW	73 kg	
LT 6-pole	0.9 kW	73 kg	
MT 4-pole	2.0 kW	65 kg	
MT 4-pole	1.3 kW	62 kg	
MT 6-pole	2.0 kW	73 kg	
HT, VH 2-pole	2.4 kW	62 kg	
VH 4-pole	2.0 kW	65 kg	
Accessories			
Denomination	Version	Nominal size of flange/hose mm	Weight
Discharge Connection	LT MT HT	100	36 kg
	MT HT VH	80	33 kg
Hose Connection	LT	100 (4")	5 kg
	MT HT	75 (3")	6 kg
Frame and Access Cover	LT MT HT VH		29 kg

Liquid temperature: max 40°C (103°F).

Liquid density: max 1100 kg/m³ (9.2 lb/US gal).

The pH of the pumped liquid: 6—11.

Depth of immersion: max 20 m (66 ft).

Starting method: Direct on-line start.

The 3085.181 can be started up to 15 times per hour.

The 3085.181 shall not be used in explosive or flammable environments or with flammable liquids.

Impeller		
Curve No.	Number of vanes	Throughlet, mm
412, 612 414, 614	1	Elliptical 100
	1	80
620, 621, 622 432, 434, 436 438, 440 632, 634, 636 250, 252	1	Circular 100
	1	76
	1	64
	1	76
	1	34
276, 278	Vortex impeller	52
470, 472, 474		76

MATERIALS

		DIN	BS
Cast parts:	Cast iron	1691 GG20	1452 Grade 14
Lower bearing	Aluminium	1725 Gk-Al Si7MgNa	LM25
Strainer:	Plastic		
Shaft:	Stainless steel	17440 X20Cr13	420 S 37
Studs, nuts and screws:	Stainless steel	X5CrNi 18/9	304S15
Lifting handle:	Galv. steel	17100 St 37	970 En3
O-rings:	Nitrile rubber (70° IRH)		
Stationary wear ring:	Brass	1705 Rg5	1400 LG2
Mechanical face seals:	Upper—Carbon/ceramic Lower—Ceramic/ceramic		

The mechanical face seals are available with tungsten carbide seal rings as optional.

Surface treatment

Impellers:	Sprayed with primer
Pump exterior:	Primed
	Finish: Black chloric rubber paint.

DIMENSIONS

All dimensions in mm (in).

Consult your local Flygt representative for sump dimensions and access frame sizes.

CP/DP

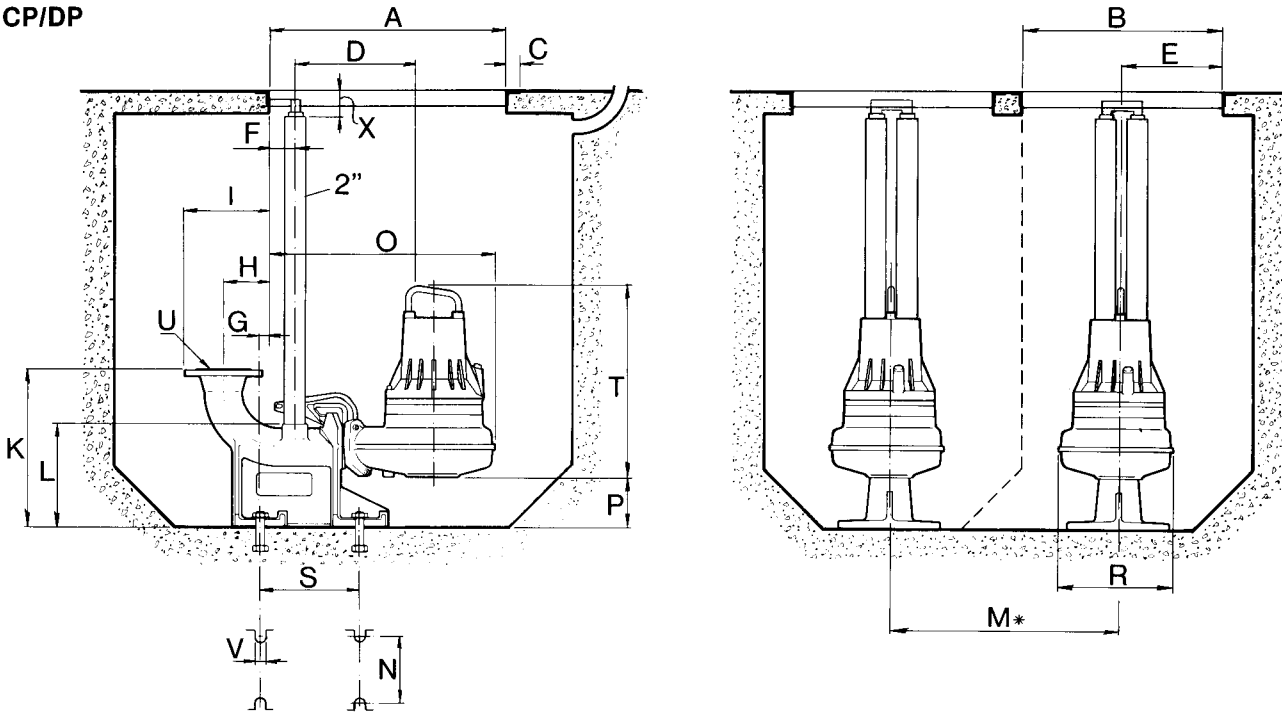

Type	A	B	C	D	E	F	G
CP- LT curve no. 412, 414, 612, 614	780 (30.7)	570 (22.4)	50 (19.7)	368 (14.5)	262 (10.3)	85 (3.3)	69 (2.7)
CP- LT curve no. 620, 621, 622	780 (30.7)	570 (22.4)	50 (19.7)	373 (14.7)	262 (10.3)	85 (3.3)	69 (2.7)
CP/DP- MT	780 (30.7)	570 (22.4)	50 (19.7)	317 (12.5)	262 (10.3)	85 (3.3)	59 (2.7)
CP- HT	780 (30.7)	570 (22.4)	50 (19.7)	317 (12.5)	262 (10.3)	85 (3.3)	59 (2.7)
DP- HT	780 (30.7)	570 (22.4)	50 (19.7)	317 (12.5)	262 (10.3)	85 (3.3)	59 (2.7)
Type	H	I	K	L	M*	N	O
CP- LT curve no. 412, 414, 612, 614	164 (6.5)	274 (10.8)	400 (15.7)	258 (10.2)	670 (26.4)	200 (7.9)	646 (25.4)
CP- LT curve no. 620, 621, 622	164 (6.5)	274 (10.8)	400 (15.7)	258 (10.2)	670 (26.4)	200 (7.9)	675 (26.6)
DP/DP- MT	154 (6.1)	254 (10.0)	400 (15.7)	258 (10.2)	670 (26.4)	200 (7.9)	593 (23.3)
CP- HT	154 (6.1)	254 (10.0)	400 (15.7)	258 (10.2)	670 (26.4)	200 (7.9)	576 (22.7)
DP- HT	154 (6.1)	254 (10.0)	400 (15.7)	258 (10.2)	670 (26.4)	200 (7.9)	576 (22.7)
Type	P	R	S	T	U	V	X
CP- LT curve no. 412, 414, 612, 614	68 (2.7)	317 (12.5)	250 (9.8)	533 (21.0)	dia. 100 (3.9)	23 (0.9)	70 (2.8)
CP- LT curve no. 620, 621, 622	95 (3.7)	365 (14.4)	250 (9.8)	520 (20.5)	dia. 100 (3.9)	23 (0.9)	70 (2.8)
CP/DP- MT	117 (4.6)	316 (12.4)	250 (9.8)	504 (19.8)	dia. 80 (3.1)	23 (0.9)	70 (2.8)
CP- HT	140 (5.5)	282 (11.1)	250 (9.8)	464 (18.3)	dia. 80 (3.1)	23 (0.9)	70 (2.8)
DP- HT	135 (5.3)	282 (11.1)	250 (9.8)	486 (19.1)	dia. 80 (3.1)	23 (0.9)	70 (2.8)

* Minimum dimension

Discharge connection:

CP/DP version

Flange, nom. size 80 mm (MT, HT) Nom. size 100 mm (LT). DIN 2533 or BS 4622.

Hose connection:

CS/DS and CF/DF version

Nom. dia 75 mm (3") MT, HT
Nom. dia 100 mm (4") LT version

The manufacturers reserve the right to alter performance, specification or design without notice.

